

Ролка Estebro® за плъзгащи се врати с втулка ф 150x20 мм, стоманена, V-20

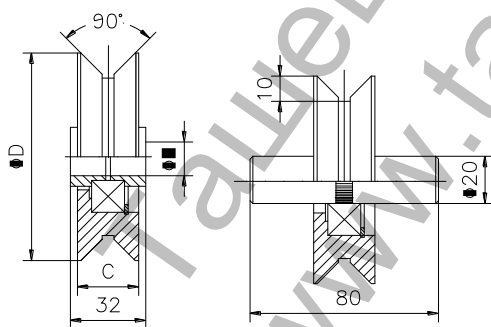

Cod	Dimens.	ØD	C	ØA			Peso Max. Kg
446	70 V	68	24	14	20	8,85	475
379	80 V	78	24	16	16	9,35	655
125	90 V	88	24	16	8	6,50	655
128	100 V	98	24	16	8	8,50	655
126	120 V	118	24	16	6	9,90	655
127	150 V	147	26	16	4	11,80	655
3562	200 V	197	26	16	4	22,35	655

Family: Wheels

Material: 11SMn30 steel

Finish: Zinc-plated

Maximum weight supported by the bearing*: See table

Description: Wheel with a bearing 6204 2RS It is installed in sliding doors to let their displacement over the guide. It can be supplied with reducing sleeves to 16 mm, or with an axle of Ø 20 mm and 80 mm long, except code 446.

***In perfect conditions of installation, usage and maintenance.**

Продукт: [Ролка Estebro® за плъзгаци се врати с втулка ф 150x20 мм, стоманена, V-20](#)

Категория: [Плъзгаци се врати](#)

Бранд: [Estebro®](#)

Категория бранд: [Ролка Estebro®](#)

Ташев-Галвинг ООД
www.tashev-galving.com